



BUSINESS CLASS

A selection by Aliseo Germany of value plus items specifically engineered to meet the demanding expectations of today's traveler.

Your Business is Our Business!

ALISEO GmbH
G E R M A N Y

ALISEO Germany

A New Culture of Hospitality

For over 30 years Aliseo has been at the forefront of a New Culture of Hospitality. An efficient reinvention of luxury, our products have been specifically engineered to provide a new source of service to the hotelier and a new level of comfort for their guests.

Successful Hoteliers realize that their hotel is no longer just a "place to stay" but a refuge to relax and regroup for the events of the next day. Today's guests want to return to a place where they can enjoy the comfort, safety and conveniences of home. These are the expectations that have become standards.

Aliseo offers technological innovation and cutting-edge aesthetics to a demanding clientele who finds in the design the exclusiveness of their identity. Much appreciated Hospitality Solutions that combine clarity of purpose with utilitarian beauty – the Aliseo Guest Experience.

The Black Forest of Germany where craftsmanship has a tradition is the source of our experience and accomplishments.



hair

SOMETHING FOR EVERYBODY

A small selection from an extensive assortment encompassing different styles, technologies, evolving tastes and budgetary concerns.

BLACK MAMBO 1875



Comfortable Soft Touch Surface with Anti-Slip Protection.

DETAILS

- 01. Comfortable soft touch coating with anti-slip protection
- 02. Variable speed & cold shot controls
- 03. 1875 Watt long-life AC-motor
- 04. Removable EZ care hair filter
- 05. Hang-up cradle design with gel pad protection



BLACK MAMBO

- Ionic technology
- Three heat settings
- Two air speeds
- Cold shot button
- AC motor
- Removable nozzle
- Overheating protection
- Double insulation
- Class II
- Coil cord, 60 cm

CE 220-240 V, 50/60 Hz, Cool / 900 / 1875 W

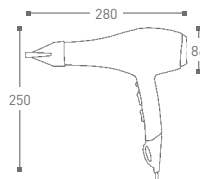

Without holder. With storage bag
With plug for plug-in application

010492 black, soft-touch

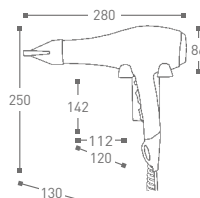

Wall holder with interrupter switch
Hard wired application

010500 black, soft-touch

CHROMO



with coil cord and plug

CHROMO

- Hotel safety switch
- Two heat/speed settings
- Removable nozzle
- Overheating protection
- Double insulation
- Class II
- Coil cord, 50 cm

 220-240 V, 50/60 Hz 600 / 1200 W

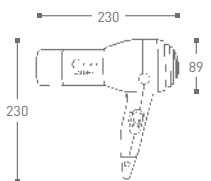

Without holder
With plug for plug-in application

010437 chrome/black, soft-touch

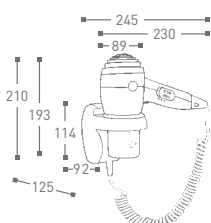

Wall holder with interrupter switch.
Hard wired.

010407 chrome/black, soft-touch

DETAILS

- 01. Soft-touch surface
- 02. Inner-ring scratch protection
- 03. Hotel safety switch
- 04. With narrow air concentrator for pinpoint styling
- 05. Comfortable ribbed anti-slip protection

AIR 1800

- Three heat settings
- Two air speeds
- Cold shot button
- DC motor
- Removable EZ care hair filter
- Removable nozzle
- Overheating protection
- Double insulation
- Class II
- 180 cm straight cord

CE 220-240 V, 50/60 Hz Cool / 900 / 1800 W

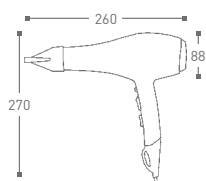

Without holder. With storage bag and velcro cable tie
With plug for plug-in application

010568 black



Generous 180 cm straight cable with velcro easy wrap tie

AIR LIGHT HAIR CARE
Maximum Comfort & Control



Contemporary profile with sure-grip handle and E-Z care mesh filter.



HIDE-AWAY 1600



DRAWER SOLUTION

When Space Is Precious



HIDE - AWAY

- Ionic technology
- 1600 Watt
- Three heat/speed settings
- Overheating protection
- Double insulation
- Class II
- Coil cord, 60 cm

220-240 V, 50/60 Hz Cool / 800 / 1600 W

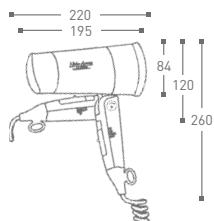

Folding handle. With storage bag
With plug for plug-in application

010394 silver/black

DETAILS

- 01. Lock-in folding handle
- 02. Variable speed



A STYLISTIC EVOLUTION
Distinctive Carbonic Optic



DETAILS

- 01. Carbonic Optic
- 02. Variable speed and cold shot controls
- 03. Removable E-Z Care Hair Filter
- 04. Hardwire DROP-IN holder with gel pad scratch protection

CARBONIC

- Ionic technology
- Three heat settings
- Two air speeds
- Cold shot button
- AC motor
- Removable nozzle
- Overheating protection
- Double insulation
- Class II
- Coil cord, 60 cm

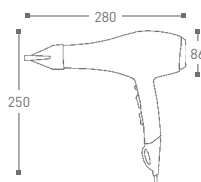

Without holder. With storage bag
With plug for plug-in application

010493 carbon-pattern

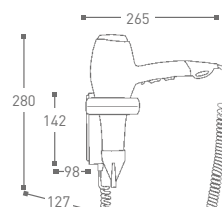

Wall holder with interrupter switch
Hard wired application

010543 carbon-pattern

CE 220-240 V, 50/60 Hz, Cool / 950 / 1900 W



WHEN ONE LOOK DESERVES ANOTHER

Technologically advanced, design sensitive reflective solutions whose stylistic diversity transforms a room into a personal statement of design.

LED MOON DANCE

Technology
Two-Tone-Touch Control



THE ULTIMATE IN COSMETIC CARE

Developed exclusively for Aliseo by sieger design, the Moon Dance features clean defined lines, new materials and lighting methodologies creating an understated sculptural form of individualized taste and technological seduction.

Translucent acrylic housing creates a distinctive backside ambient light. Circular motif, soft dorsal curvature and smooth textured finish simulate the nocturnal celestial body.



LED MOON DANCE

product concept + design: **sieger design**

SMD-LED-lighting
Warm white light, 3500-4000 K
Cool white light, 5000-5500 K
3x magnification
Hi-tech touch control
Translucent acrylic frame
Full pivotal adjustment
Class I
100-240 V
Hard wire application
Brass construction

IP44



Free standing
chrome, \varnothing 240 mm
plug
020759

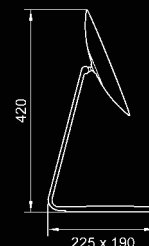

On single arm
chrome, \varnothing 240 mm
020758

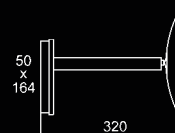

LED SATURN



Illuminated touch sensor



T³Technology



Choice of a warm white or cool white reflection
Full circle high intensity LED illumination
50,000 hour maintenance free

LED SATURN

SMD-LED-lighting
Warm white light, 3500-4000 K
Cool white light, 5000-5500 K
3x magnification
Hi-tech touch control
Full pivotal adjustment
Class I
100-240 V
Hard wire application
Brass construction

IP44



On single arm
chrome, \varnothing 220 mm
020743

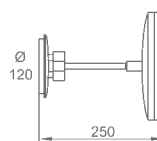

On Twin arm
chrome, \varnothing 220 mm
020744

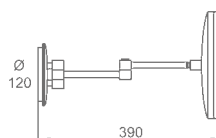

T³Technology



Illuminated touch sensor
Variable Day or Night time Illumination



“The Mirror Has Two Faces”



Two independent LED systems with different pigmentations

LED CUBIK

- SMD-LED-lighting
- Warm white light, 3500-4000 K
- Cool white light, 5000-5500 K
- 3x magnification
- Hi-tech touch control
- Full pivotal adjustment
- Class I
- 100-240 V
- Hard wire application
- Brass construction

IP44



On single arm
chrome, 215 x 215 mm
020745

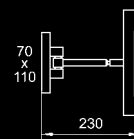

On twin arm
chrome, 215 x 215 mm
020746

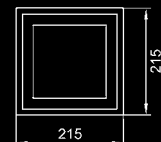
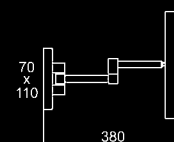

LED CITY LIGHT

LED

Green
Efficiency



"Lighting the Way"

Generous 25 cm diameter
Full circle LED pin-point imaging
50,000 hour maintenance free illumination
3 x reflection

LED CITY LIGHT

SMD-LED-lighting
Warm white light, 3500-4000 K
3x magnification
Full pivotal adjustment
Class I
120-240 V
Hard wire application



On single arm
chrome, ø 250 mm
020677

On twin arm
chrome, ø 250 mm
020657

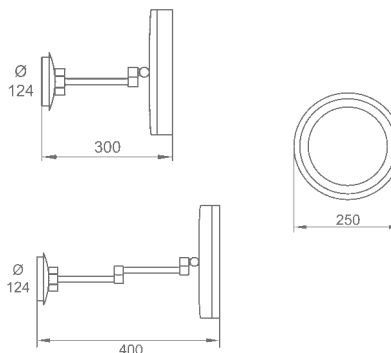

NEW

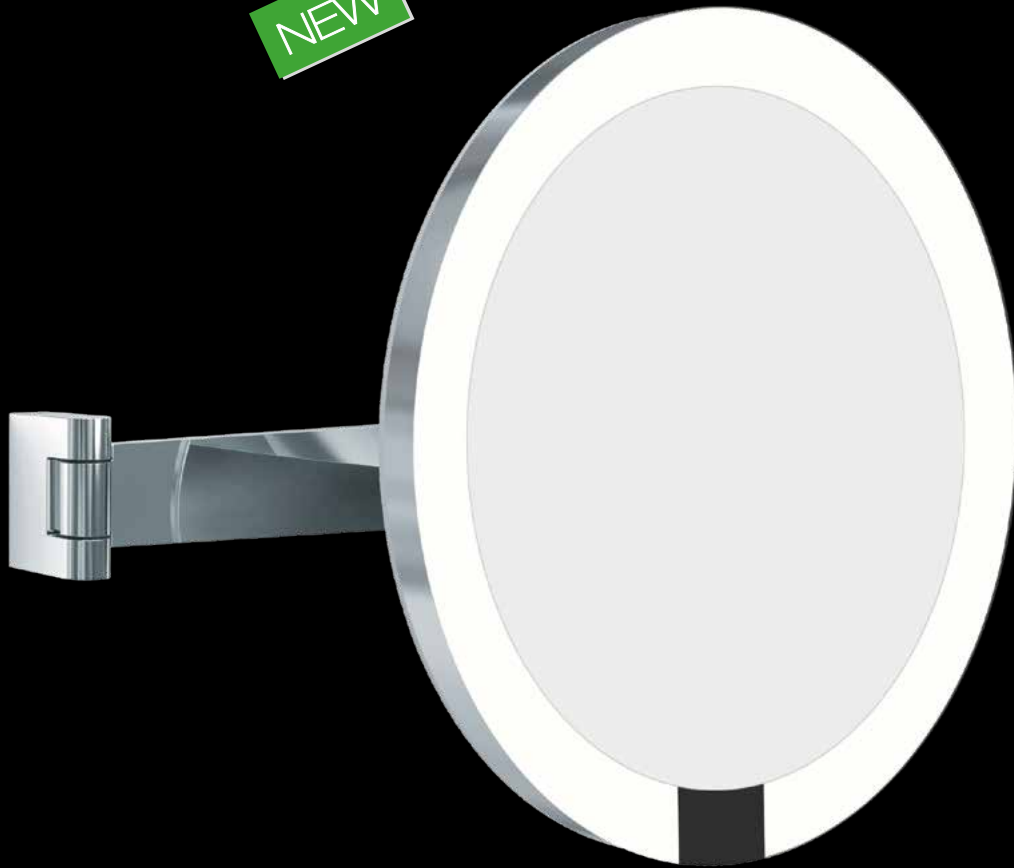

“Invisible Technology“

Lights automatically as your face approaches...

Auto ON/OFF infrared sensor activates a translucent acrylic edge LED lighting system. Operational up to 20 cm.

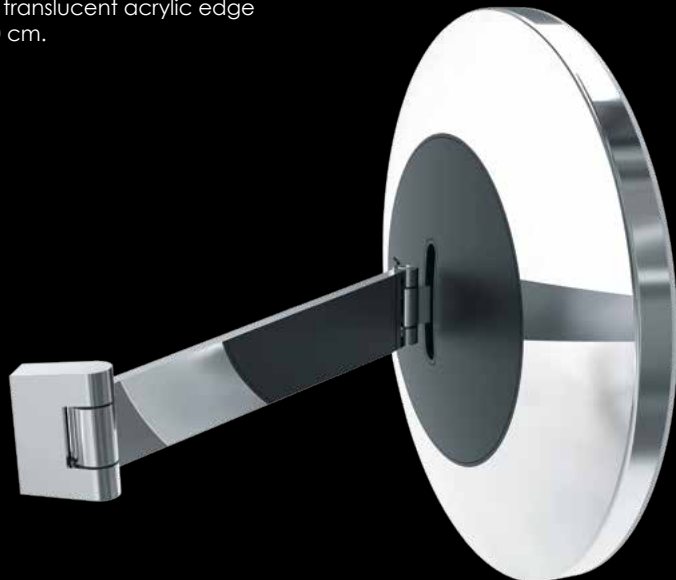
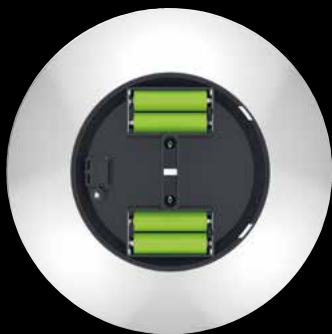

LED INTERFACE

Battery powered
SMD-LED-lighting
Warm white light, 3500-4000 K
3x magnification
Sturdy reinforced pivot joint
Brass components



On single arm
chrome, \varnothing 220 mm
020796

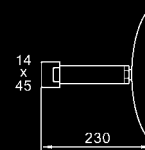

FACE



"Fashionably Flexible"

FACE

3x magnification
Full pivotal adjustment
Covered backplate

On single arm
chrome, \varnothing 200 mm
020795

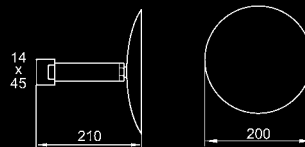

COSMO MINIMALIST

3x magnification
Full pivotal adjustment
Covered backplate
Brass components

On single arm
chrome, \varnothing 200 mm

020607

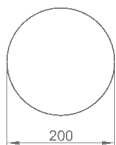
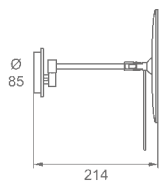

“Something Special”



Secure Mounting:
Separate mounting bracket
Maximum stability
A finished elegant appearance

CONCIERGE

Plain and 3x magnification
Covered backplate
Brass components



On single arm
chrome, \varnothing 200 mm

020506

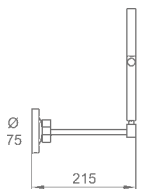

On twin arm
chrome, \varnothing 200 mm

020507

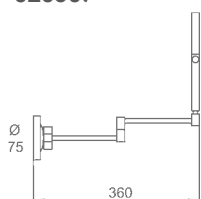

“A Contemporary Classic”



Secure Mounting:
Separate mounting bracket
Maximum stability
A finished elegant appearance

TECNO - Subtle Strength

Distinctive profile combines elegantly powerful lines within a contemporary profile.

Covered Screws

Material: Brass

Finish: Chrome



710051



710003



710052



Towel Rail



710043
Hook



710008
Toilet Roll Holder



710015
Towel Ring



710009
Spare Roll Holder



710013
Toilet Roll Holder



710010
Toilet Brush Holder
Iced Glass





ARTIS - Accessory Art
 Slender space-saving accessories that embrace a fresh square form.
 Covered Screws
 Material: Zinc & Stainless Steel
 Finish: Chrome



320001

320002

Towel Rail





320006
Hook



320004
Toilet Roll Holder



320007
Towel Ring



320005
Spare Roll Holder



320003
Toilet Roll Holder



320010
Toilet Brush Holder
Iced Glass





NOW - It's Time

Clean contemporary practical forms come of age.
 Covered Screws
 Material: Brass
 Finish: Chrome



	740022	740002	740013
Towel Rail			



740016
Hook



740003
Towel Ring



740007
Toilet Roll Holder



740008
Toilet Roll Holder



740017
Spare Roll Holder



740006
Toilet Roll Holder



740009
Toilet Brush Holder
Iced Glass





HOOK it Up!



030527

Hook
Brass, chrome finish



030538

Hook
Brass, chrome finish



030539

Hook
Brass, chrome finish



730002

Hook
Brass, chrome finish



HOOK IT UP



740016
Hook
Brass, chrome finish

50 | 48
48



780004
Hook
Brass, chrome finish

56 | 46
46



740004
Double Hook
Brass, chrome finish

55 | 48
82



710006
Hook
Brass, chrome finish

55 | 59
54



710014
Double Hook
Brass, chrome finish

55 | 59
96



710042
Double Hook
Brass, chrome finish

74 | 54
80

Essentials

There when you need it!

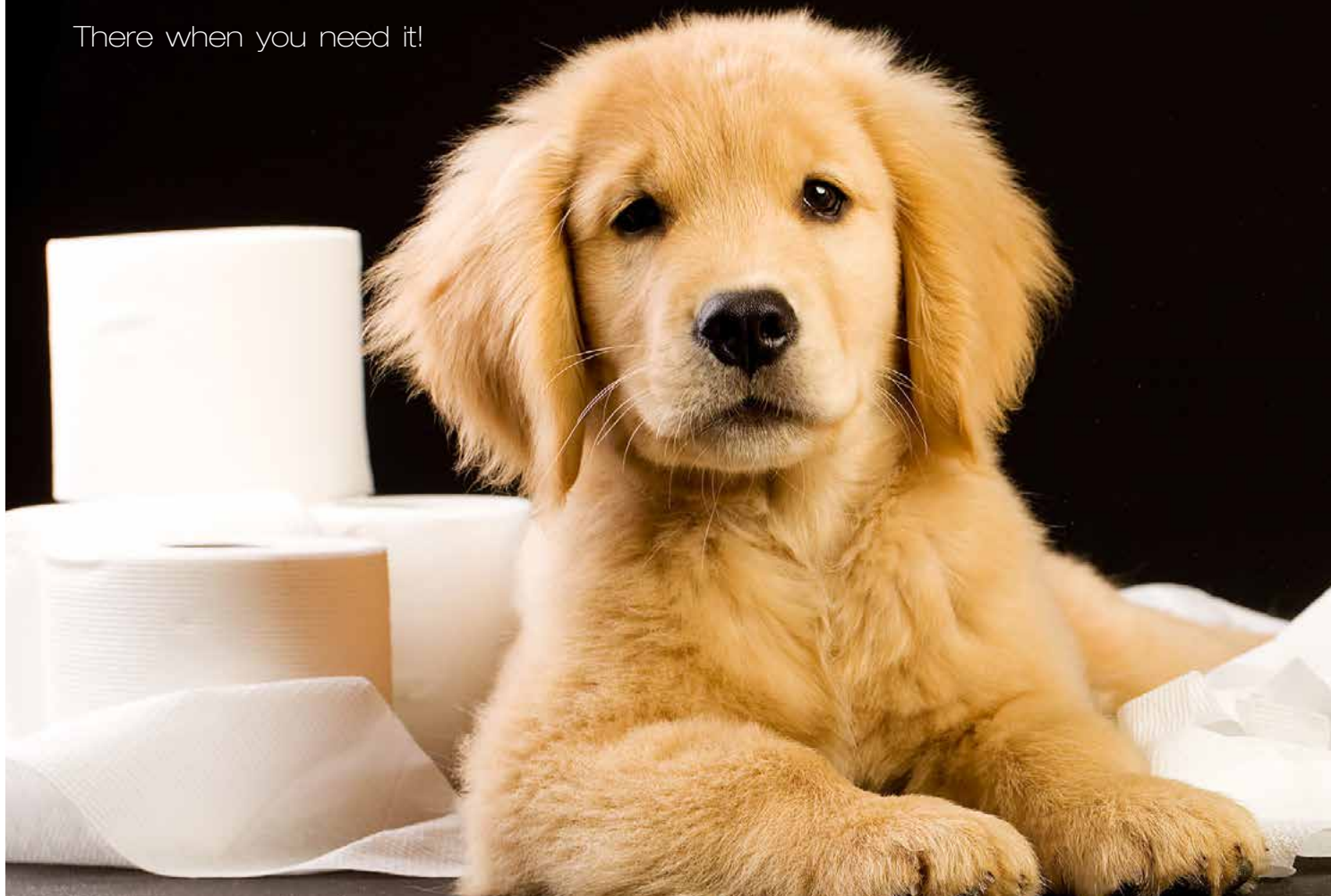

030481
Toilet Brush Holder
Iced Glass. Brass, chrome finish

130 | 365
96



740018
Toilet Brush Holder. Free standing
Stainless steel, chrome finish

84 | 360

NEW



030652
ON CALL
Toilet Roll Holder
With shelf for mobile phones
Stainless steel, shiny finish



030416
Clothes Line
Brass, chrome finish



030615
Soap Dispenser MOON
Iced Glass. Brass, chrome finish



030628
Sanitary Bag Dispenser
Plastic, chrome finish



030506
Tissue Dispenser CUBE
Plastic, chrome finish



PRESTIGE - Designed For A Difference

Contemporary craftsmanship at its finest, Aliseo's sensible technology and intelligent solutions combine clarity of purpose with utilitarian beauty.

The Art of Living just got easier.



Smart Sensible Solutions



Silent Soft Close System



Removable Inner Bucket



Fingerprint Resistant Coating



Solid Footing – non skid base



030654 - 3 L

030655 - 5 L

PRESTIGE
Step Bin
Removable plastic inner bin
Stainless steel, brushed finish

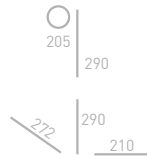
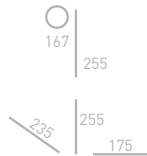

030657

PRESTIGE
Step Bin - 5 L
Removable plastic inner bin
Stainless steel, brushed finish
Dent-proof plastic lid

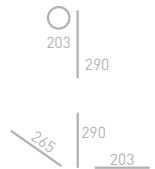

030656

PRESTIGE
Step Bin - 6 L
Removable plastic inner bin
Stainless steel, brushed finish

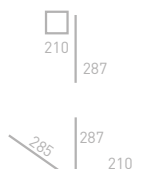

Apartment Applications

030659

PRESTIGE - EZ Stay
Step Bin - 10 L + 9 L
Removable plastic inner bin
Stainless steel, brushed finish

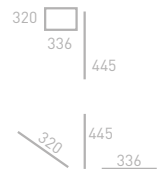





030544
TEMPO

Electronic
8 mm-thick safety glass
Capacity max. 180 kg
Graduation 100 g
Switchable to pounds (lbs)
4 integrated sensors
Auto shut-off
80 x 40 mm LCD display
with blue backlight
4x AAA batteries
Material underpart: ABS plastic



030653
STEP SCALE

Electronic
6 mm-thick safety glass
Capacity max. 150 kg
Graduation 100 g
Switchable to pounds (lbs)
Step-on technology
4 integrated sensors
Auto shut-off
1 x 3V lithium battery
Material frame and
underpart: ABS plastic



030475
FUTURA

Electronic
6 mm-thick safety glass
Capacity max. 200 kg
Graduation 100 g
Switchable to pounds (lbs)
4 integrated sensors
Auto shut-off
Long-life Lithium battery
Material underpart: Corrosion
resistant Epoxy-plastic coating



030626
NEVIS

Electronic
6 mm-thick safety glass
Capacity max. 150 kg
Graduation 100 g
Switchable to pounds (lbs)
Step-On technology
4 integrated sensors
Auto shut-off
3 x 1.5V-AAA batteries
Material underpart: ABS plastic







MINI TRAY ENSEMBLE

Eco-luxe efficiency combines water and energy saving functions in a small space
... It all makes sense

160259 SPACE OASIS

- 170211 MINI Water Kettle
brushed chrome / black
- 170254 BRIDGE TRAY, wooden tray with drawer
260 x 44 x 160 mm (W x H x D)
Material: bamboo and melamine
mahogany / matt black
- 170258 Ceramic Mug (2 pcs.)
250 ml
black, inside white
Height 100 mm, Ø 85 mm



MINI
0,5 liter
water-saving design

Black/White
Ceramic Mugs



BRIDGE TRAY
Elegantly finished bamboo construction
Durable melamine condiment tray



Smaller is Smarter - Water & Energy Saving

4.



5.



1. Safety-grip handle with illuminated power switch
2. Cylindrical low-profile 0.5 liter footprint; stainless steel construction with brushed surface finish
3. 360° STRIX interface platform ensures guest's safety while optimizing performance
4. Sturdy interlocking safety lid
5. Easy pour spout with wide mouth fill

170211

MINI

Brushed chrome/black
0.5 litre capacity
Integrated heating element
Cordless, 360° rotation
STRIX control
Automatic shut-off
Boil dry protection
Indicator light
Lid with safety interlock
Stainless steel housing



220-240 V, 50/60 Hz 1000 W

SASO

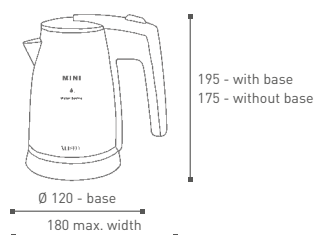
**MINI**

All Aliseo kettles incorporate patented STRIX or OTTER controls ensuring auto shut-off, boil dry protection and steam shut-down functions for maximum guest safety.



WELCOME TRAY SOLUTIONS



- 01. Serving tray 324 x 21 x 131
- 02. Base tray 400 x 20 x 330
- 03. Sachet tray 130 x 40 x 100

WELCOME TRAY SOLUTION

Tray set
 Black
 Material: Melamine with porcelain optic

Complete Set **170229**

Base Tray **170226**
 Serving Tray **170227**
 Sachet Tray **170228**





Shiny stainless steel

Brushed stainless steel

FUSION

- 1.0 litre capacity
- Concealed heating element
- Cordless, 360° rotation
- STRIX control
- Replaceable filter
- Automatic shut-off
- Boil dry protection
- Indicator light
- External level indicator
- Lid with safety interlock
- Heat resistant, easy care plastic housing with stainless steel casing

  220-240 V, 50 Hz 1850-22000 W

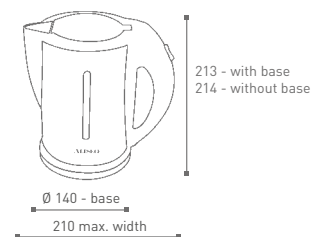

- 170119** shiny stainless steel/black
- 170124** brushed stainless steel/black

WELCOME TRAY SOLUTION

EcoSmart
Energy Saving, 1200 W



* Shown with Welcome Tray

170167

EMPIRE

chrome/ black
0.8 litre capacity
Concealed heating element
Cordless, 360° rotation
STRIX control
Automatic shut-off
Boil dry protection
Indicator light
Lid with safety interlock
Stainless steel housing



220-240 V, 50/60 Hz 1000-1200 W



Elegant chrome finish

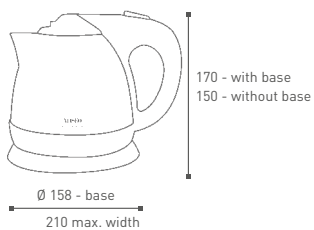



ECCO

1000 watt
0.6 liter design



* Shown with Manila Tray and Puzzle boxes



* Shown with Manila Tray and Puzzle box

Puzzle boxes integrated into etched tray

MANILA

Wooden Tray
Material: Bamboo

Colour Options



black



natur

360 x 20 x 260 mm
170221 natur
170222 black

310 x 20 x 180 mm
170223 natur
170224 black

PUZZLE

Sachet Box
Material: Melamine
with porcelain optic

Colour Options



black



ivory

151 x 55 x 76 mm
170240 black
170238 ivory

76 x 55 x 76 mm
170241 black
170239 ivory

Bonjour



Easy to maintain, water saving and energy aware, Bonjour is a fresh efficient addition to any welcome tray presentation.

Designed for a Difference

1. Double wall construction – stainless steel cylinder with a cool-touch stain resistant thermoplastic exterior
2. Sturdy interlocking safety lid with wide-mouth aperture - easy to fill and clean
3. Full grip safety handle with illuminated power switch

BONJOUR

0.6 litre capacity
 Cordless, 360° degree rotation
 Integrated heating element
 STRIX control
 Automatic shut-off
 Boil dry protection
 Indicator light
 Lid with safety interlock
 Double wall construction:
 Inner stainless steel cylinder
 Insulated thermoplastic exterior



220-240 V, 50/60 Hz 1000 W



185 - with base
 165 - without base

∅ 134 - base
 190 max. width

170281 black matt
 170282 ivory/ black



1.



2.



3.

COURTESY TRAY



* Shown with Bonjour kettle and Puzzle boxes.
Coffee machine and capsules are decoration

COURTESY TRAY

Low profile porcelain optic tablets provide an attractive setting for Nespresso® coffee machines and/or Tea service presentations. Durable melamine construction is easy to clean and resistant to splintering and cracking. Works individually or collectively in combination with any number of similar coffee machines and tea kettle ensembles.

* Product names, brands and trademarks™ or registered® trademarks are the property of their respective holders. Use of them does not imply any affiliation with or endorsement by them. It is for reference only and serves no other purposes.

170277 COURTESY TRAY

black
400 x 200 x 16 mm
Material: Melamine with porcelain optic

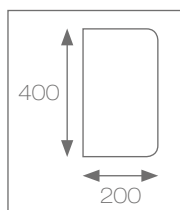

170282 BONJOUR

Water kettle
ivory/ black
0.6 litre capacity

170239 PUZZLE

Sachet Box
ivory
Material: Melamine with porcelain optic

NEW



“All in ONE”

Space-conscious square platform is durable, compact and practical. Fabricated from ABS with a simulated wood grain finish, the TEA STATION is an attractive cost-saving alternative. Accommodates Aliseo's MINI, Fusion and Bonjour kettles.

An “All in ONE” sensible solution.

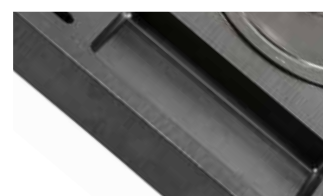

For FUSION , MINI & BONJOUR Kettles only

TEA STATION

Durable black ABS construction
 Attractive simulated wood grain finish
 Heat, water, stain & scratch resistant
 Recessed platform (Ø 145 mm / depth 19 mm)
 for MINI and Fusion kettles
 Theft-proof cord pass through
 Open condiment storage & grooved tea bag slots
 Recessed drip reservoir with stainless grill cover
 4 corner silicone furniture bumpers
 Tray 258 x 40 x 258 mm (W x H x D)

- 170265** Tray with FUSION kettle, shiny stainless steel
 - 170268** Tray with FUSION kettle, brushed stainless steel
 - 170271** Tray with MINI kettle, brushed stainless steel
 - 170287** Tray with BONJOUR kettle, black matt
 - 170288** Tray with BONJOUR kettle, ivory/black
- * Shown with optional black/white ceramic mugs
- 170258** Ceramic Mug, 250 ml, height 100 mm, Ø 85 mm



TV PROGRAMMLISTE

- 1 ARD
- 2 RTL
- 3 ZDF
- 4 ORF 1
- 5 ORF 2
- 6 RTL 2
- 7 RTL 3
- 8 RTL 4
- 9 RTL 5
- 10 RTL 6
- 11 RTL 7
- 12 RTL 8
- 13 RTL 9
- 14 RTL 10
- 15 RTL 11
- 16 RTL 12
- 17 RTL 13
- 18 RTL 14
- 19 RTL 15
- 20 RTL 16
- 21 RTL 17
- 22 RTL 18
- 23 RTL 19
- 24 RTL 20
- 25 RTL 21
- 26 RTL 22
- 27 RTL 23
- 28 RTL 24
- 29 RTL 25
- 30 RTL 26
- 31 RTL 27
- 32 RTL 28
- 33 RTL 29
- 34 RTL 30
- 35 RTL 31
- 36 RTL 32
- 37 RTL 33
- 38 RTL 34
- 39 RTL 35
- 40 RTL 36
- 41 RTL 37
- 42 RTL 38
- 43 RTL 39
- 44 RTL 40
- 45 RTL 41
- 46 RTL 42
- 47 RTL 43
- 48 RTL 44
- 49 RTL 45
- 50 RTL 46
- 51 RTL 47
- 52 RTL 48
- 53 RTL 49
- 54 RTL 50
- 55 RTL 51
- 56 RTL 52
- 57 RTL 53
- 58 RTL 54
- 59 RTL 55
- 60 RTL 56
- 61 RTL 57
- 62 RTL 58
- 63 RTL 59
- 64 RTL 60
- 65 RTL 61
- 66 RTL 62
- 67 RTL 63
- 68 RTL 64
- 69 RTL 65
- 70 RTL 66
- 71 RTL 67
- 72 RTL 68
- 73 RTL 69
- 74 RTL 70
- 75 RTL 71
- 76 RTL 72
- 77 RTL 73
- 78 RTL 74
- 79 RTL 75
- 80 RTL 76
- 81 RTL 77
- 82 RTL 78
- 83 RTL 79
- 84 RTL 80
- 85 RTL 81
- 86 RTL 82
- 87 RTL 83
- 88 RTL 84
- 89 RTL 85
- 90 RTL 86
- 91 RTL 87
- 92 RTL 88
- 93 RTL 89
- 94 RTL 90
- 95 RTL 91
- 96 RTL 92
- 97 RTL 93
- 98 RTL 94
- 99 RTL 95
- 100 RTL 96

Radio - Sender

- 16 RUM
- 17 SWR1
- 18 SWR2
- 19 SWR3
- 20 SWR4
- 21 SWR5
- 22 SWR6
- 23 SWR7
- 24 SWR8
- 25 SWR9
- 26 SWR10
- 27 SWR11
- 28 SWR12
- 29 SWR13
- 30 SWR14
- 31 SWR15
- 32 SWR16
- 33 SWR17
- 34 SWR18
- 35 SWR19
- 36 SWR20
- 37 SWR21
- 38 SWR22
- 39 SWR23
- 40 SWR24
- 41 SWR25
- 42 SWR26
- 43 SWR27
- 44 SWR28
- 45 SWR29
- 46 SWR30
- 47 SWR31
- 48 SWR32
- 49 SWR33
- 50 SWR34
- 51 SWR35
- 52 SWR36
- 53 SWR37
- 54 SWR38
- 55 SWR39
- 56 SWR40
- 57 SWR41
- 58 SWR42
- 59 SWR43
- 60 SWR44
- 61 SWR45
- 62 SWR46
- 63 SWR47
- 64 SWR48
- 65 SWR49
- 66 SWR50
- 67 SWR51
- 68 SWR52
- 69 SWR53
- 70 SWR54
- 71 SWR55
- 72 SWR56
- 73 SWR57
- 74 SWR58
- 75 SWR59
- 76 SWR60
- 77 SWR61
- 78 SWR62
- 79 SWR63
- 80 SWR64
- 81 SWR65
- 82 SWR66
- 83 SWR67
- 84 SWR68
- 85 SWR69
- 86 SWR70
- 87 SWR71
- 88 SWR72
- 89 SWR73
- 90 SWR74
- 91 SWR75
- 92 SWR76
- 93 SWR77
- 94 SWR78
- 95 SWR79
- 96 SWR80
- 97 SWR81
- 98 SWR82
- 99 SWR83
- 100 SWR84

THE LONDONER



THE LONDONER

Embodies a fine tradition of style and class. Hand-crafted faux leather accoutrements provide a rich appearance and long lasting service. An enduring statement of quality, sophistication and function.

THE LONDONER



190030
Desk Pad
with magnetic fold

405 | 14
500



190027
Service Binder A5
with two ring clamp

40 | 245
193



190028
Service Binder A4
with two ring clamp

40 | 320
246



190026
Waste Bin - 10 L
with removable metal liner

235 | 363
235



190025
Waste Bin - 9 L
Metal with removable faux leather casing

225 | 270



* Shown with Fusion kettle



190003
Sachet Box
with two compartments



190001
Tray



190016
Tissue Dispenser
with magnetic trap at the bottom



190017
Tissue Dispenser
with magnetic trap at the bottom



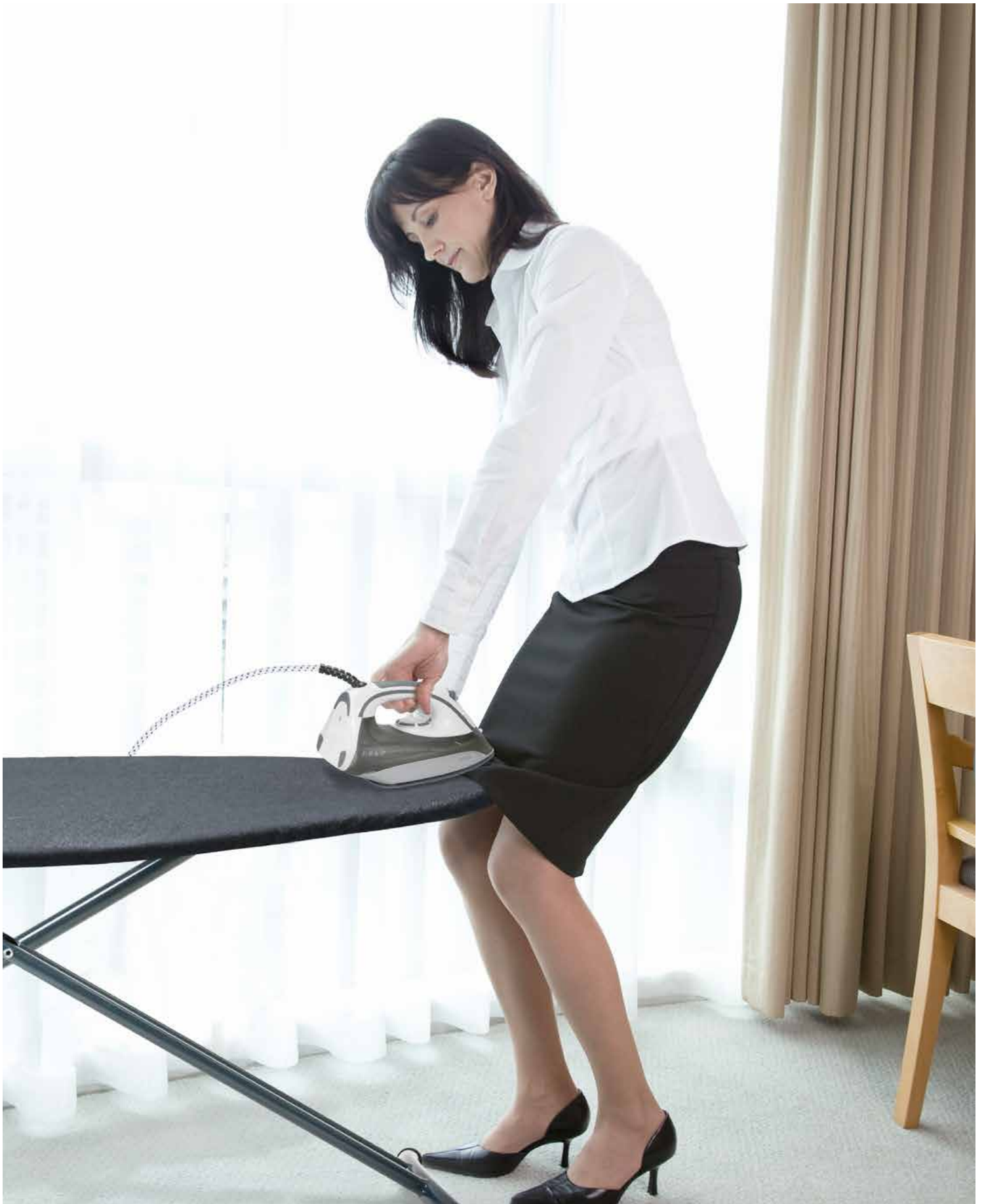

A VARIETY OF CHOICES ... A VARIETY OF NEEDS



Hotel-smart boards are spacious enough for travel pressing yet lightweight and compact for easy maneuverability and hang-up storage.

All irons feature double safety auto shut-offs; all fixed holders incorporate heat resistant anti-scratch bumpers, theft protection and easy cable storage.



160162
STEAMWORKS

Hotel steam iron
white/ silver
Energy saving - 1650-2000 W
Double safety automatic shut-off
Non-stick ceramic soleplate
Anti-calc and anti-drip system
Self cleaning system
Weight 1.1 kg

Intertek   220-240 V, 50/60 Hz 1650-2000 W

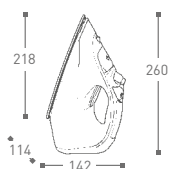

- 01. Finger-tip Steam Function
- 02. Full-range spray adjustment with temperature control light
- 03. Rotating Fabric Control Dial



ENGINEERED FOR PERFORMANCE

- Automatic Hotel safety shut-off - horizontal after 30 seconds/vertical after 8 minutes
- E-Z-glide non-stick CERAMIC soleplate
- Dial Fabric Control locks out at 200° C – guards against accidental scorching of fabric
- Easy front fill clear water tank: capacity 200 ml/6.8 oz.



SAHARA - Works When Dry





160172
SAHARA

Hotel dry iron
silver/champagne
EcoSmart - 900-1100 W
Double safety automatic shut-off
Fabric control dial
Non-stick ceramic soleplate
Weight 0.8 kg

- 01. E-Z glide non-stick coating
- 02. Double safety automatic shut-off

CE 220-240 V, 50/60 Hz 900-1100 W

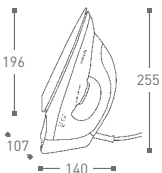

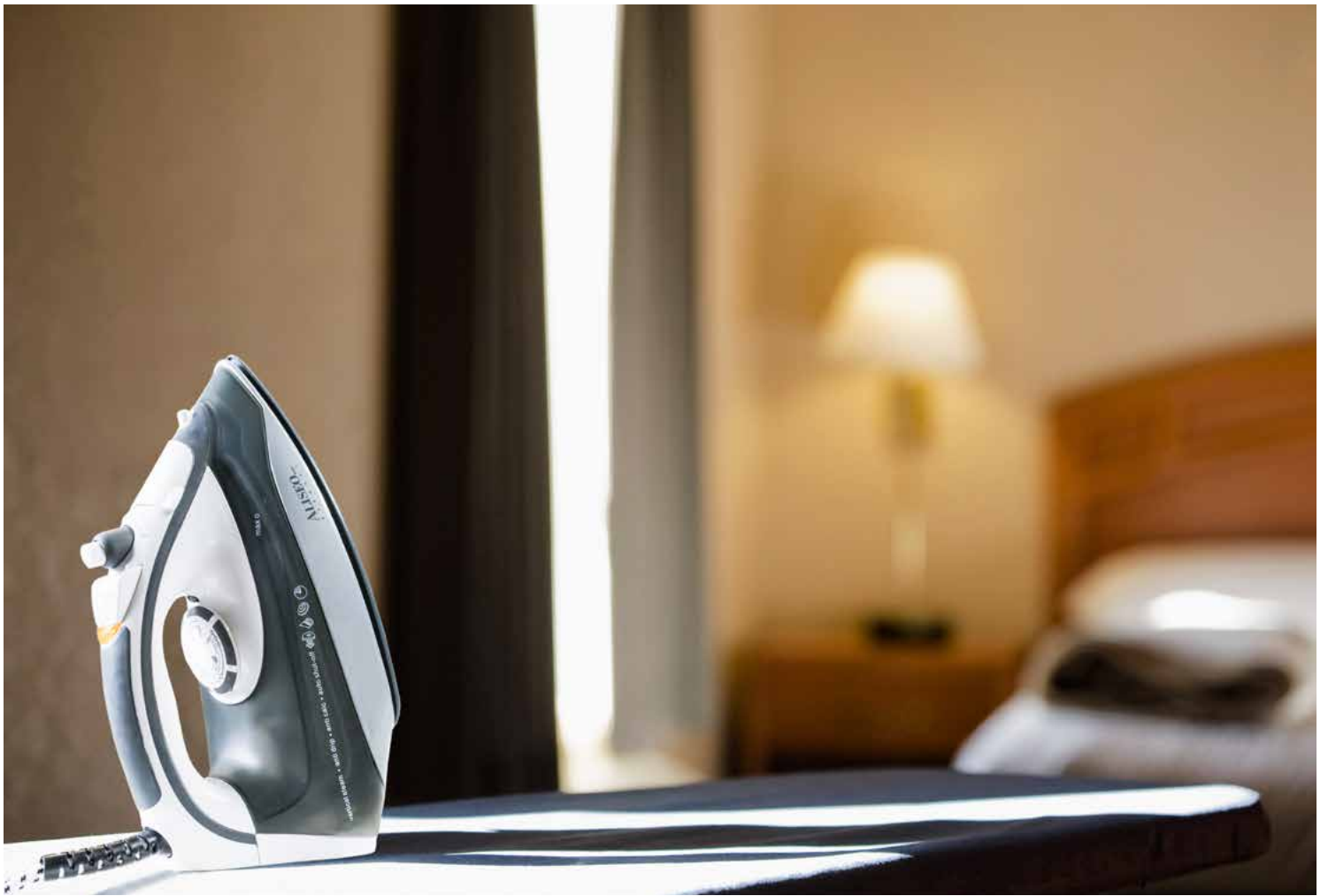

ALISEO HANG-UP

Hang-up organizer
 black
 Heat resistant back plate
 Mounted with or without board hanger

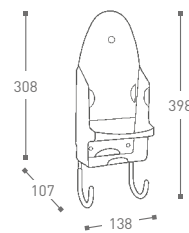

160183
 for steam iron SteamWorks

160130
 for dry iron Sahara



Fold-away suspension hook

Integrated extension cord



E-ZEE CONCEPT

- Ironing board with iron rest
- Anti-Fire cover with foam underlay
- Height adjustable up to 89 cm
- Sturdy frame with transport safety lock
- Material legs: tubular steel
- Powder coated silver finish

160167

- E-ZEE STEAMWORKS
- Ironing board with steam iron

160175

- E-ZEE SAHARA
- Ironing board with Dry iron

160111

- E-ZEE
- Ironing board

Weight

Board E-Zee	4,3 kg
Extension Cord	0,3 kg
Iron SteamWorks	1,1 kg

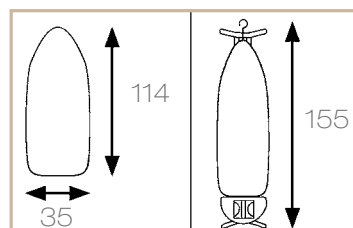



Integrated hang-up hook with
Space-saving cradle design



Integrated Schuko extension cord

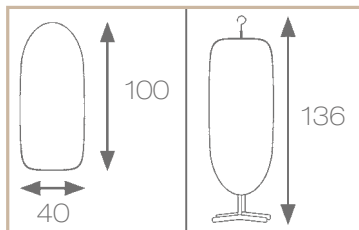

Weight

Board Surf	4,6 kg
Holder	0,4 kg
Extension cord	0,3 kg
Iron SteamWorks	1,1 kg
Total	6,4 kg

SURF CENTER

- Ironing board with safety cradle
- Anti-Fire cover with foam underlay
- Suspension hook
- Sturdy frame with transport safety lock
- Material legs: tubular steel
- Powder coated silver finish

160164

SURF CENTER STEAMWORKS
Ironing board with steam iron

160178

SURF CENTER SAHARA
Ironing board with dry iron

160132

SURF BOARD
Ironing board without safety cradle

160181

IRON CRADLE
Suspension hook, cable reel with clip for easy storage
Heat resistant space-saving design, Anti-theft protection -
cable guard secured through the board



Height adjustment 84 - 87 - 90 cm



Anti-theft protection - cable guard secured through the board

On-Board Hotel Safety Holders

Fixed holder design is engineered to provide maximum efficiency and security. Iron is firmly secured to the holder which is fixed in place to the board. Heat and scratch resistant silicone bumpers protects the ceramic soleplate from scratching. Theft-proof reel design provides neat wind-up cable storage. Irons are secured safely in place for easy vertical cupboard stowing.

On-Board Fixed Holder Design



- 01. Iron rests securely in place on heat resistant non-slip silicone bumpers
- 02. Replaceable bumpers are fastened to the holder via soft-pointed silicone inserts
- 03. Theft protection – cable secured through the holder/board



Integrated Cable Reel and Clip for neat easy storage



Integrated Schuko extension cord

A Variety of Choices
for a Variety of Needs

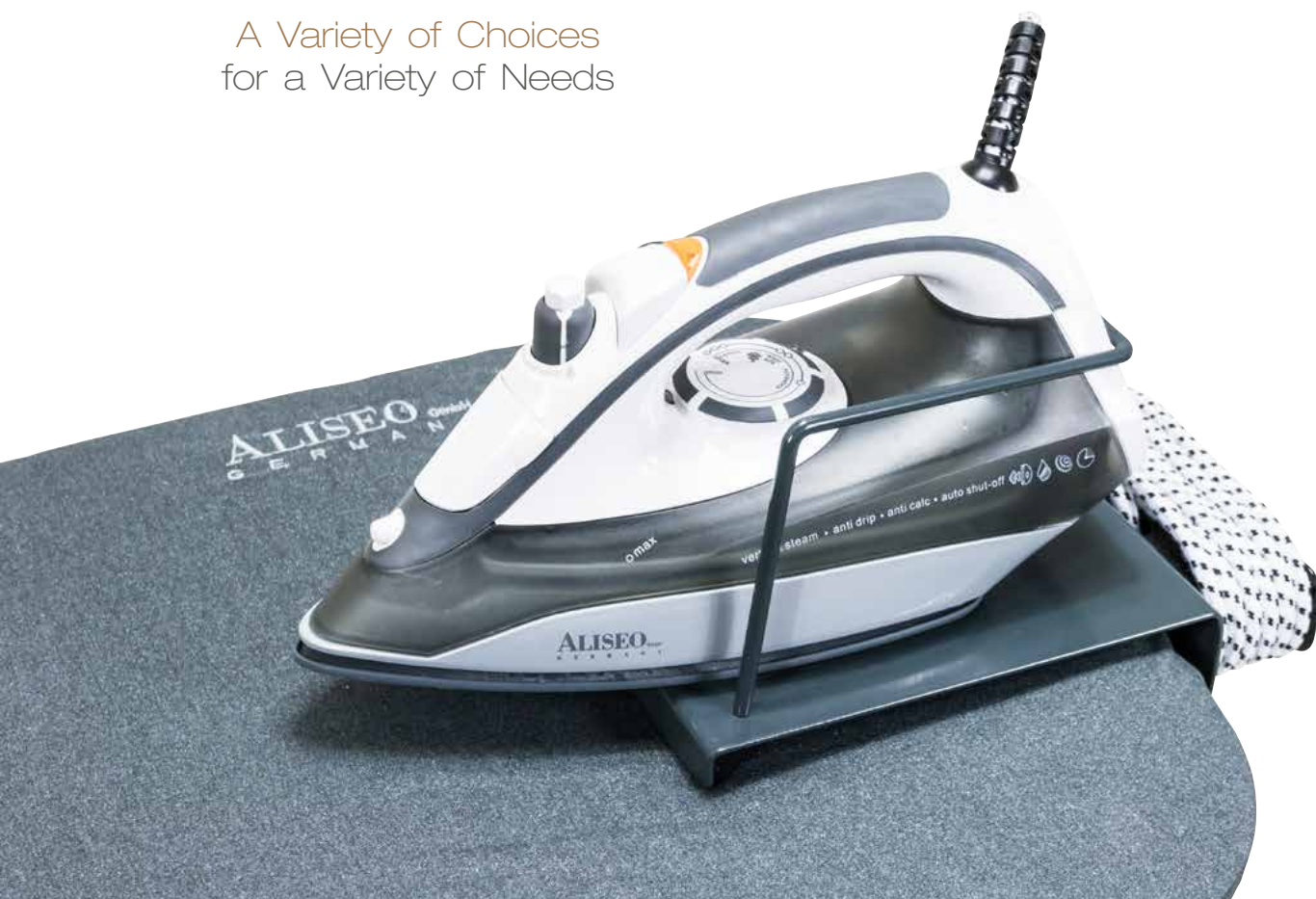

Holder thru-bolted directly onto
Aliseo boards:
MI-PRO, MINI-MAX, MINI-MEE



Irons are secured safely in place for
board storage in hanging position





MINI-MAX

Minimum Profile - Maximum Board Space

Specifically engineered for small cabinet storage

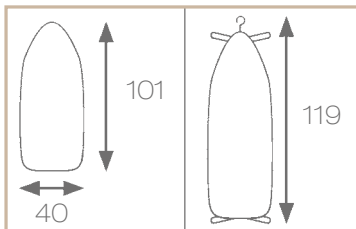

Integrated Schuko extension cord

Weight

Board Mini-Max	4,4 kg
Holder	1,0 kg
Extension cord	0,3 kg
Iron SteamWorks	1,1 kg
Total	6,8 kg



160209

MINI-MAX STEAMWORKS
Ironing board with safety holder and steam iron

160206

MINI-MAX SAHARA
Ironing board with safety holder and dry iron

160215

MINI-MAX
Ironing board without safety holder

160192

Iron Holder
Cable reel with clip for neat easy storage
Heat resistant safety iron cradle
Replaceable silicone pads
Anti-theft protection - cable guard secured through the board

MINI-MAX

Ironing board with fixed safety iron holder
Anti-Fire cover with foam underlay
Height adjustable up to 78 cm
Integrated Schuko extension cord
Fold-away suspension hook
Sturdy frame with transport safety lock
Material legs: tubular steel
Powder coated dark grey finish

MINI-MEEE



MINI-MEEE

TABLE TOP IRONING BOARD

With fixed safety iron holder
 Anti-Fire cover with foam underlay
 Fold-away suspension hook
 Material legs: tubular steel
 Powder coated black finish



Sturdy frame with platform safety lock



160197

MINI-MEEE STEAMWORKS
 Table top ironing board with safety holder and steam iron

160194

MINI-MEEE SAHARA
 Table top ironing board with safety holder and dry iron

160188

MINI-MEEE
 Table top ironing board without safety holder

Weight

Board Mini-Meee	1,9 kg
Holder	1,0 kg
Iron SteamWorks	1,1 kg
Total	4,0 kg

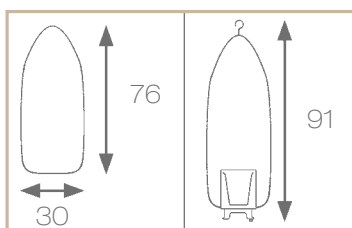

You're As Good As
the Company You Keep !



With over thirty years of experience and more than 1 million installations on 6 continents, Aliseo has a unique understanding of hospitality needs - from design dictates and cultural sensitivities to electrical requirements and safety standards.

By incorporating the latest technology with the needs of today's travellers, Aliseo has developed a wide range of innovative products that bring value to the hotelier and convenience to their guest.

A dedication to quality, design and innovation that is shared by many of the world's top hoteliers.

These are but a few . . .

THE PENINSULA ▪ Paris | FOUR SEASONS ▪ Budapest | ARMANI Hotel ▪ Milano | THE SAVOY ▪ London | CASA DE CAMPO ▪ Dominican Republic | SAN CLEMENTE PALACE KEMPINSKI ▪ Venice | FAIRMONT ▪ Monte Carlo | SHANGRI-LA AT THE SHARD ▪ London | HOTEL EMILIANO ▪ Sao Paulo | SANDY LANE ▪ Barbados | FOUR SEASONS ▪ Milano | HANSEN KEMPINSKI ▪ Vienna | THE ROYAL MANSOUR ▪ Marrakech | PARK PLAZA ▪ Washington, D.C. | BELMOND REID'S PALACE ▪ Madeira | EMIRATES PALACE ▪ Abu Dhabi | GRAND HOTEL et de MILAN ▪ Milano | THE WESTIN ▪ Hamburg | MILLENIUM Hotel ▪ Qatar | SHANGRI-LA ▪ Fiji | THE ALPINA Gstaad ▪ Switzerland | ARIA Hotel ▪ Budapest | WALDORF ASTORIA ▪ Berlin | CONRAD ▪ Cairo | MANDARIN ORIENTAL ▪ Paris | HOTEL DE L'EUROPE ▪ Amsterdam | BELMOND REID'S PALACE ▪ Madeira | THE PENINSULA ▪ New York City | GRAND HYATT ▪ Istanbul | GRAND EMERALD HOTEL ▪ St. Petersburg | FOUR SEASONS ▪ Florence | KEMPINSKI Mall of the Emirates ▪ Dubai | THE PENINSULA ▪ Beijing | BURJ AL ARAB ▪ Dubai | THE RITZ-CARLTON ▪ Istanbul | HOTEL TAJ ▪ Cape Town | MARINA BAY SANDS ▪ Singapore | NATIONAL HOTEL ▪ Moscow | STEIGENBERGER WILTCHER'S ▪ Brussels

ALISEO GmbH
G E R M A N Y

www.aliseo.de

